

# Cable Tray

Medium Duty Return Flange Cable Tray

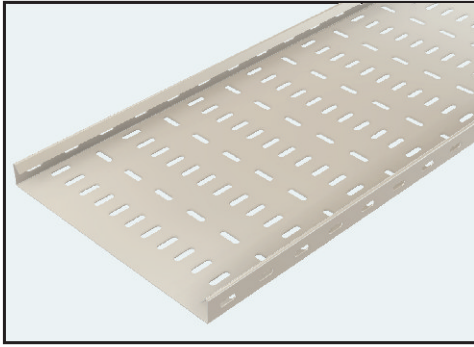

**R30 CABLE TRAY STRAIGHT X 3M**

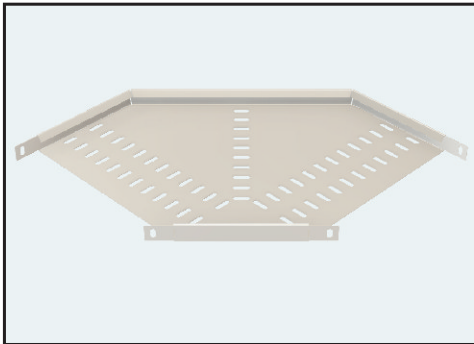

**R30 CABLE TRAY HORIZONTAL BEND**

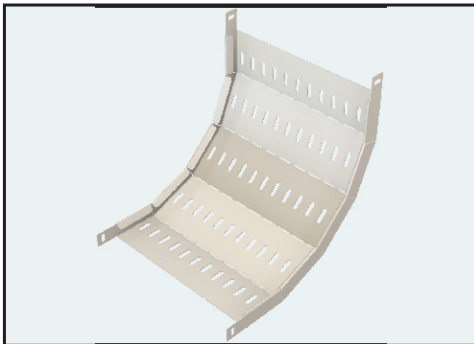

**R30 CABLE TRAY INTERNAL BEND**  
USED AS INTERNAL BEND=90°,60°,45°,30°

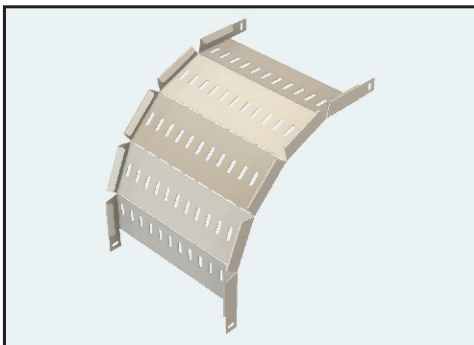

**R30 CABLE TRAY EXTERNAL BEND**  
USED AS EXTERNAL BEND=90°,60°,45°,30°

Part No:	Finish		W
R30/50	PG	SS	50 mm
R30/75	PG	SS	75 mm
R30/100	PG	SS	100 mm
R30/150	PG	SS	150 mm
R30/225	PG	SS	225 mm
R30/300	PG	SS	300 mm
R30/450	PG	SS	450 mm
R30/600	PG	SS	600 mm
R30/900	PG	SS	900 mm

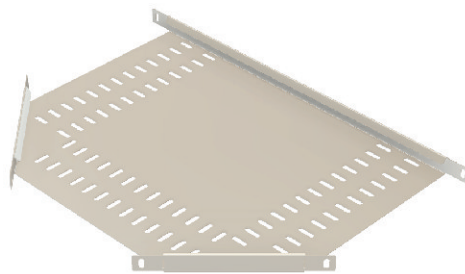

**R30 CABLE TRAY TEE**

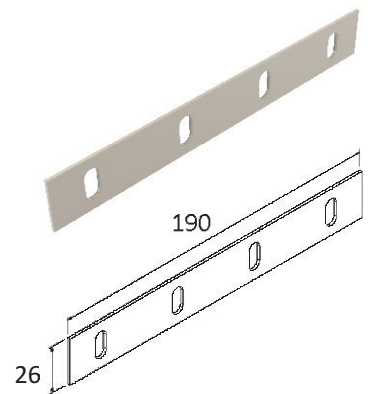

**R30 SPLICE SET**

**Straight Section Tray**

**Hardware:**

2 Off: Splice Plates

8 Off: M6x12 Gutter Bolt & Nuts  
(W=450-900mm): Add on

1 Off: Centre Splice

4 Off: M6x12 Gutter Bolt & Nuts

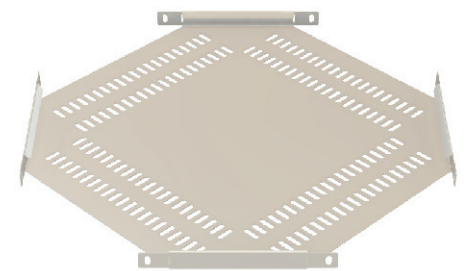

**R30 CABLE TRAY 4-WAY**

Designed For Your Cable Support Requirements.